



LOW PRESSURE CENTRIFUGAL FANS

CBM Series



Range of double inlet direct driven low pressure centrifugal fans manufactured from **galvanised sheet steel**.

All the models are fitted with forward curved centrifugal impellers manufactured from galvanized sheet steel.

Motors

Housing closed motors, IP44, class F, equipped with thermal protection and ball bearings greased for life.

Electrical supply:

Single phase 230V-50Hz (capacitor fitted on the fan housing).

Three phase 230/400V-50Hz.

(See characteristics chart).

Working temperatures from -20°C to +40°C.

On request

Housing open motors IP20, class F.

Coupling flange fitted at the fan outlet (B version).

Special version kitchen IP55, class F.

Three phase motors suitable for frequency inverter control with motor E22 version.

Anti-vibration mounts



All motors are fitted with support including rubber antivibration mounts **reducing the noise** transmitted to the installation

Impeller dynamically balanced



Impeller dynamically balanced, according to ISO 1940 standard, providing vibration free operation

APPLICATIONS



Incorporation in ventilation cabinets



Air conditioning equipment

POSITIONS

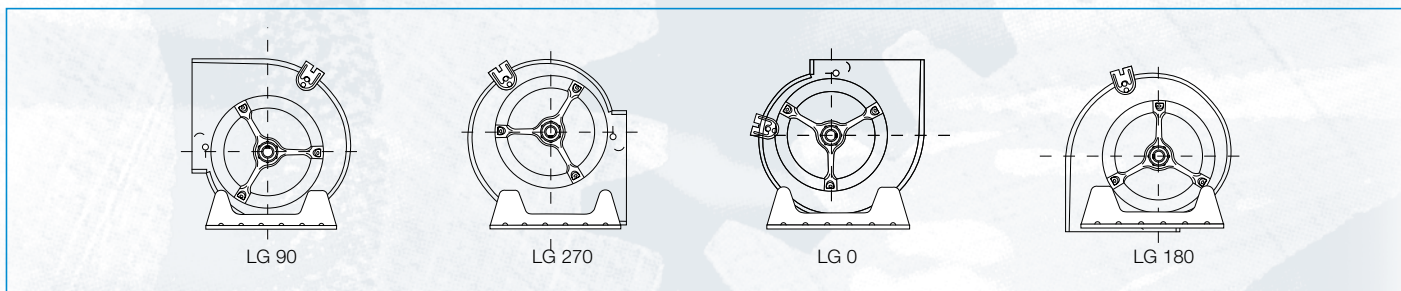

Mounting feet (accessory) allow 4 positions of the inlet discharge.

■ Technical characteristics

Before installation check that the product electrical characteristics listed on the data plate label (Voltage, power, frequency etc) match those of the intended electrical supply.

Model	Motor power		Equiv. in inches	Poles	Capacitor (μ F / V)	Maximum absorbed current (A)		Airflow (m ³ /h)	Sound pressure level* (dB(A))	Weight (Kg)
	(W)	(CV)				230V/1/50Hz	230-400V/3/50Hz			
CBM/6-180/180 T 72W	72	1/10	7/7	6	3/450	0,77	-	1395	55	9
CBM/4-180/180 T 147W	147	1/5	7/7	4	5/450	1,55	-	1540	57	10
CBM/6-240/180 T 122W	122	1/6	9/7	6	6/450	1,30	-	2170	60	16
CBM/6-240/180 T 245W	247	1/3	9/7	6	10/450	2,04	-	2600	64	16
CBM/6-240/240 T 122W	122	1/6	9/9	6	6/450	2,05	-	2360	60	17
CBM/6-240/240 T 245W	247	1/3	9/9	6	10/450	2,23	-	2860	64	17
CBM/4-240/240 T 373W	373	1/2	9/9	4	10/450	3,85	-	2770	66	19
CBM/6-270/200 T 245W	247	1/3	10/8	6	10/450	2,30	-	2730	62	18
CBM/6-270/200 T 373W	373	1/2	10/8	6	15/450	4,15	-	4100	73	19
CBM/4-270/200 T 373W	373	1/2	10/8	4	25/400	4,50	-	3280	67	19
CBM/6-270/270 T 245W	245	1/3	10/10	6	10/450	2,35	-	3080	60	21
CBM/6-270/270 T 373W	373	1/2	10/10	6	15/450	4,40	-	4700	70	21
CBM/4-270/270 T 550W	550	3/4	10/10	4	25/450	4,40	-	3300	66	23
CBM/6-320/240 T 550W	550	3/4	12/9	6	18/450	6,00	-	4770	67	28
CBM/6-320/240 T 1100W (trif.)	1100	1,5	12/9	6	-	-	7,1/4,1	6300	73	28
CBM/6-320/320 T 550W	550	3/4	12/12	6	18/450	5,30	-	4740	66	30
CBM/6-320/320 T 1100W (trif.)	1100	1,5	12/12	6	-	-	7,3/4,2	7420	74	30
CBM-RTC/6-380/380-2200W (trif.)	2200	3	15/15	6	-	-	8,8/5,1	8950	72	45

* Sound pressure levels in dB(A), measured at 1,5 meters at the fan inlet side in free field.



■ Dimensions (mm)

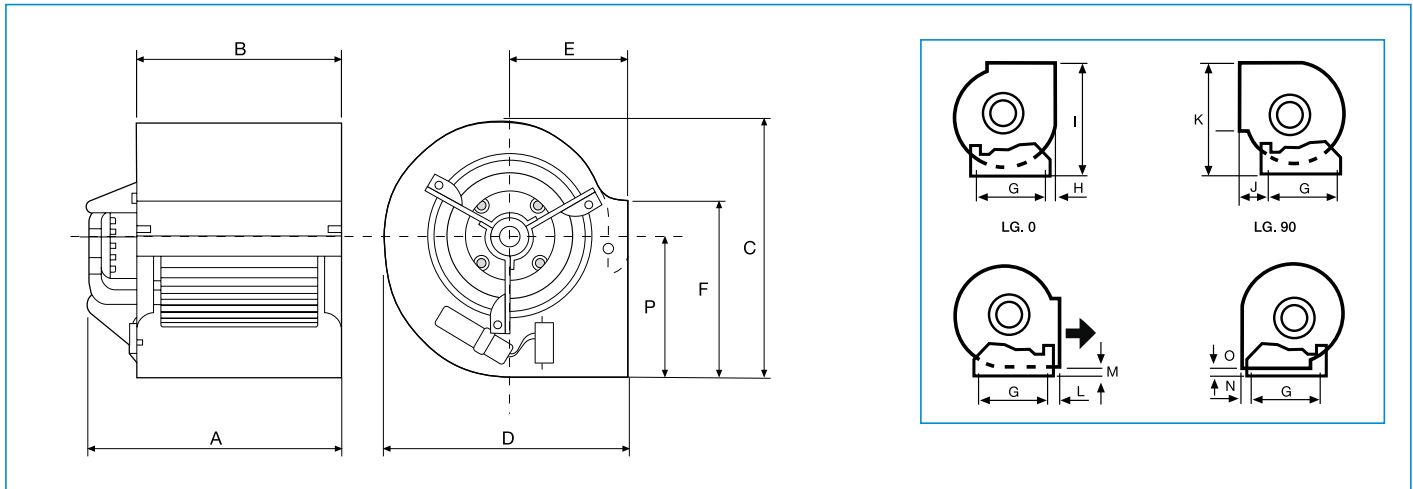

Model	A	B	C	D	E	F	G	H	I	J	K	L	M	N	O	P
CBM/6-180/180 (72W /147W)	270	233	327	308	145	207	225	47,6	314	57	333	28	16,4	8,6	6	187
CBM/4-180/180 (147W)	284	233	327	308	145	207	225	47,6	314	57	333	28	16,4	8,6	6	187
CBM/6-240/180 (122W)	306	234	390	381	184	260	296	34,5	382	69	395,5	68,5	39	34,5	6	221
CBM/6-240/180 (245W)	318	234	390	381	184	260	296	34,5	382	69	395,5	68,5	39	34,5	6	221
CBM-240/240 (122W/6-245W /6-373W/4)	348	300	390	381	184	260	296	34,5	382	69	395,5	68,5	39	34,5	6	221
CBM-270/200 (245W/6-373W/4)	328	267	443	423	200	288	339	39	427	67	451,5	67	40	39	8	249
CBM/6-270/200 (373W)	367	267	443	423	200	288	339	39	427	67	451,5	67	40	39	8	249
CBM/6-270/270 (245W)	377	333	443	423	200	288	339	39	427	67	451,5	67	40	39	8	249
CBM/6-270/270 (373W)	418	333	443	423	200	288	339	39	427	67	451,5	67	40	39	8	249
CBM/4-270/270 (550W)	430	333	443	423	200	288	339	39	427	67	451,5	67	40	39	8	249
CBM/6-320/240 (550W)	419	311	521	490	229	341	407	40,5	496,5	69,5	528,5	69,5	38,5	41,5	4,5	293
CBM/6-320/240 (1100W)	416	311	521	490	229	341	407	40,5	496,5	69,5	528,5	69,5	38,5	41,5	4,5	293
CBM/6-320/320 (550W)	459	396	521	490	229	341	407	40,5	496,5	69,5	528,5	69,5	38,5	41,5	4,5	293
CBM/6-320/320 (1000W)	460	396	521	490	229	341	407	40,5	496,5	69,5	528,5	69,5	38,5	41,5	4,5	293

■ Dimensions CBM 380/380 (mm)

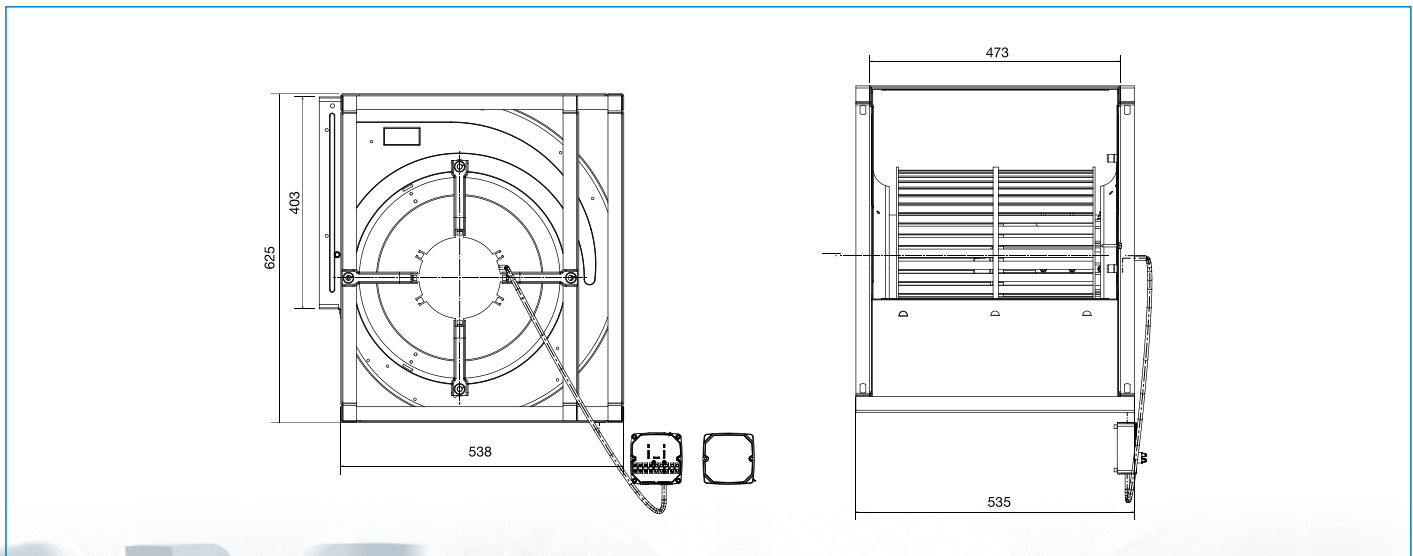

■ Mounting accessories



Outlet flange CBM



Mounting feet



Inlet guard

Model	Outlet flange CBM	Mounting feet	Inlet guard
CBM-180/180	Brida desc. CBM-180/180	PIE SOPORTE CBP/CBM 7/7	DEF-CBM-180
CBM-240/180	Brida desc. CBM-240/180	PIE SOPORTE CBP/CBM 9/9	DEF-CBM-240
CBM/6-240/240-122W	Brida desc. CBM-240/240	PIE SOPORTE CBP/CBM 9/9	DEF-CBM-240
CBM/6-240/240-245W	Brida desc. CBM-240/240	PIE SOPORTE CBP/CBM 9/9	DEF-CBM-240
CBM/4-240/240-373W	Brida desc. CBM-240/240	PIE SOPORTE CBP/CBM 9/9	DEF-CBM-240
CBM/6-270/200-245W	Brida desc. CBM-270/200	PIE SOPORTE CBP/CBM 10/10	DEF-CBM-270
CBM/6-270/200-373W	Brida desc. CBM-270/200	PIE SOPORTE CBP/CBM 10/10	DEF-CBM-270
CBM/4-270/200-373W	Brida desc. CBM-270/200	PIE SOPORTE CBP/CBM 10/10	DEF-CBM-270
CBM/6-270/270-245W	Brida desc. CBM-270/270	PIE SOPORTE CBP/CBM 10/10	DEF-CBM-270
CBM/6-270/270-373W	Brida desc. CBM-270/270	PIE SOPORTE CBP/CBM 10/10	DEF-CBM-270
CBM/4-270/270-550W	Brida desc. CBM-270/270	PIE SOPORTE CBP/CBM 10/10	DEF-CBM-270
CBM-320/240	Brida desc. CBM-320/240	PIE SOPORTE CBP/CBM 12/12	DEF-CBM-320
CBM-320/320	Brida desc. CBM-320/320	PIE SOPORTE CBP/CBM 12/12	DEF-CBM-320
CBM-RTC-380/380	-	-	DEF-CBM-380

■ Accessories dimensions

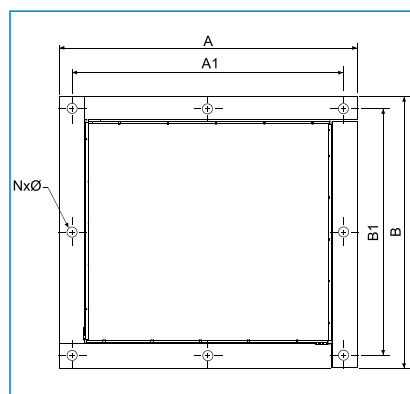

Outlet flange CBM	A	A1	B	B1	NxØ (mm)
Brida desc. CBM-180/180	289	264	265	240	8x9
Brida desc. CBM-240/180	273	253	302	280	8x9
Brida desc. CBM-240/240	360	328	315	285	8x10
Brida desc. CBM-270/200	314	293	339	316	8x9
Brida desc. CBM-270/270	380,5	359	339	316	8x9
Brida desc. CBM-320/240	362	341	394,5	374	8x9
Brida desc. CBM-320/320	447	426	394,5	374	8x9



Mounting feet

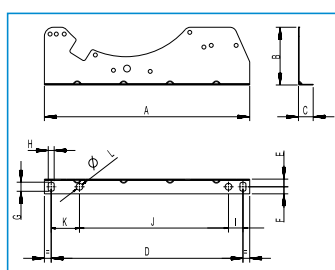

Model	A	B	C	D	E	F	G	H	I	J	K	L
7/	254	47	26	227	13,5	12,5	16	10,5	15	195	15	12
9/	325	102	26	297	13,5	12,5	16	10,5	-	-	35,7	10,5
10/	363	102	26	339	13,5	12,5	16	10,5	37,5	263,5	62	12
12/	434	144	26	407	13,5	12,5	16	10,5	48	333,5	25,5	12



■ Performance curves

- Q = Air volume in, m³/hr and m³/s.
- Ps = Static pressure in mmWG and Pa.
- Dry air at 20°C and 760 mmHg.
- Performance data in accordance with ISO 5801 and AMCA 210-99 Standards.

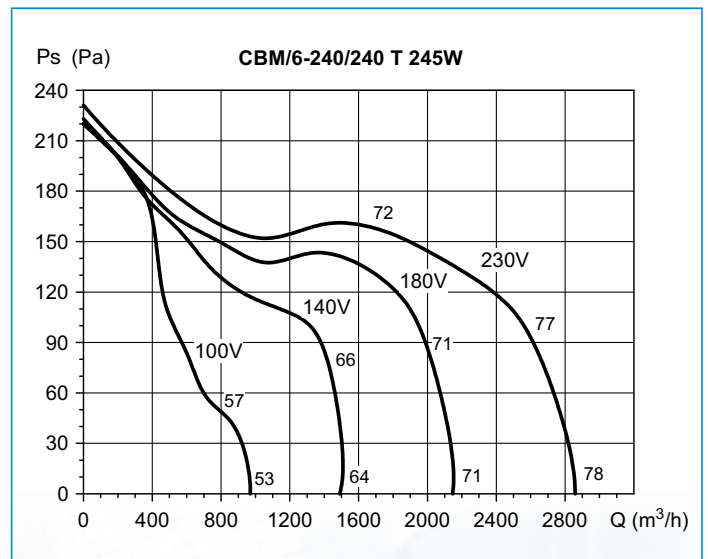
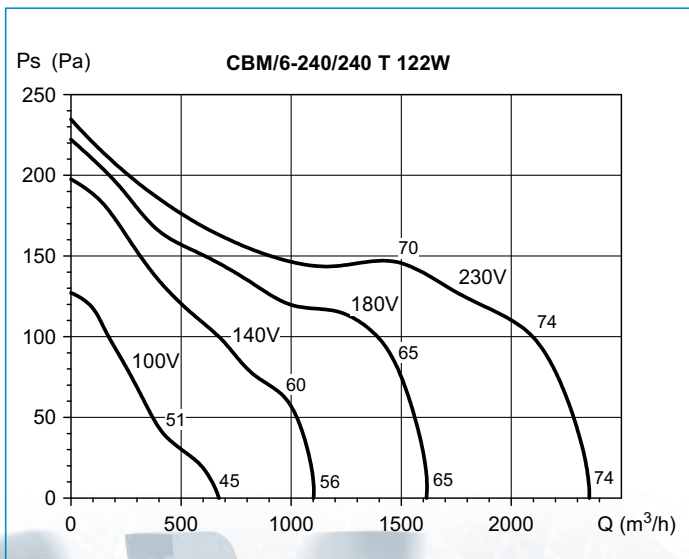
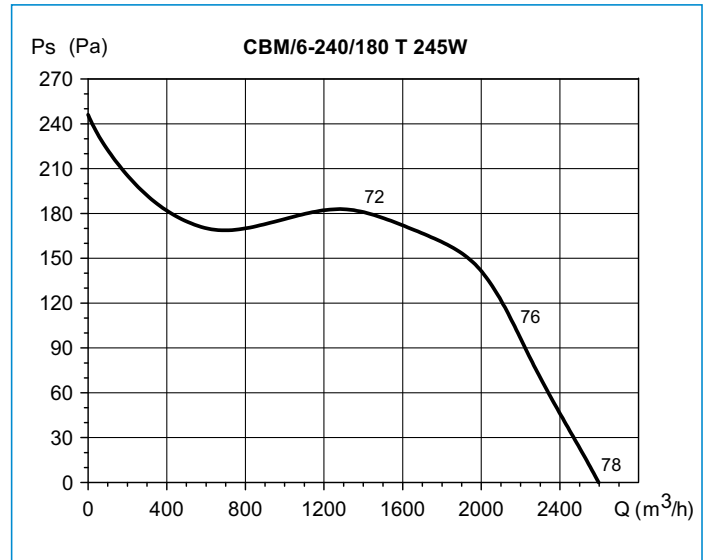
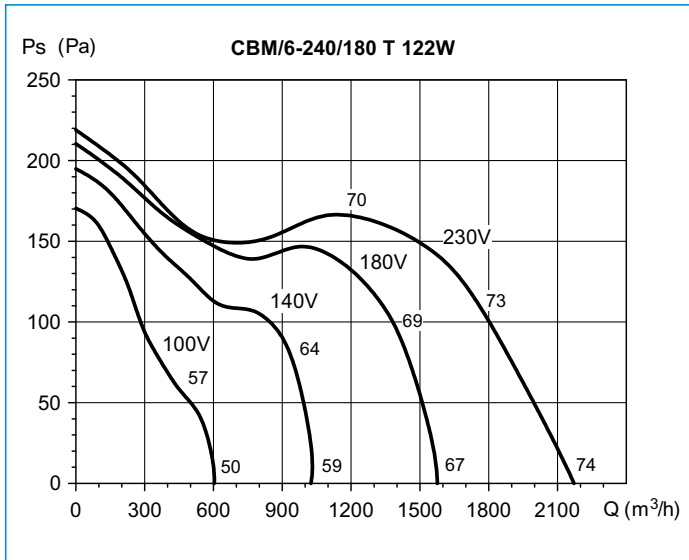
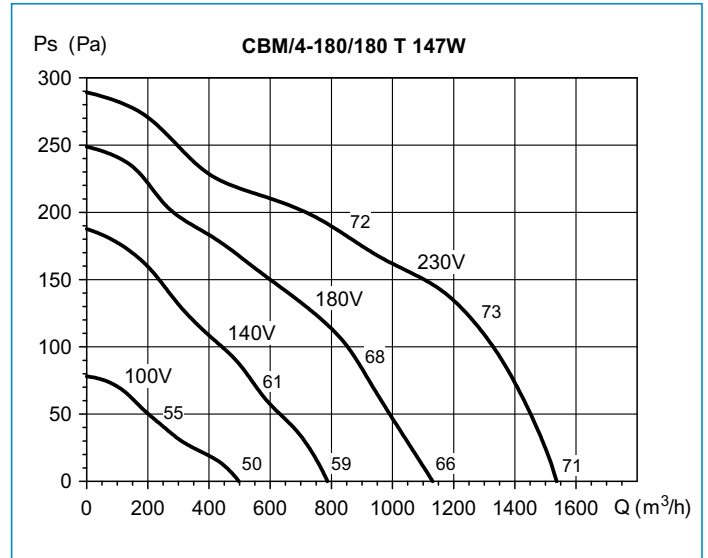
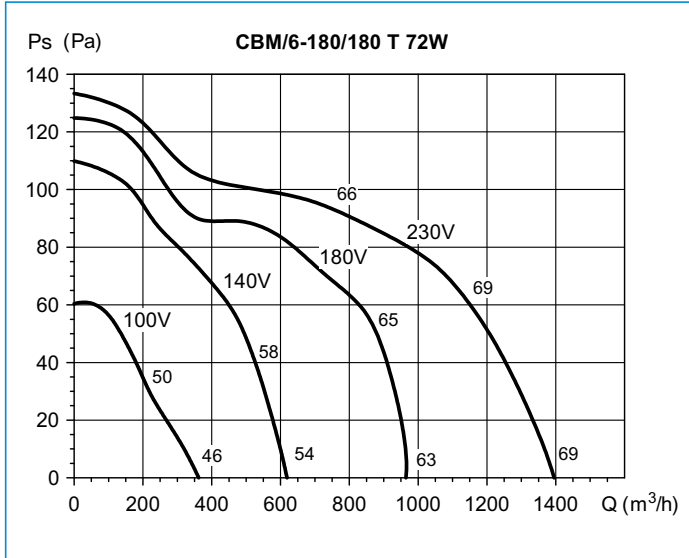

Curves at different voltages are obtained with a transformer type speed controller.

Performance curves

- Q = Air volume in, m³/hr and m³/s.
- Ps = Static pressure in mmWG and Pa.
- Dry air at 20°C and 760 mmHg.
- Performance data in accordance with ISO 5801 and AMCA 210-99 Standards.

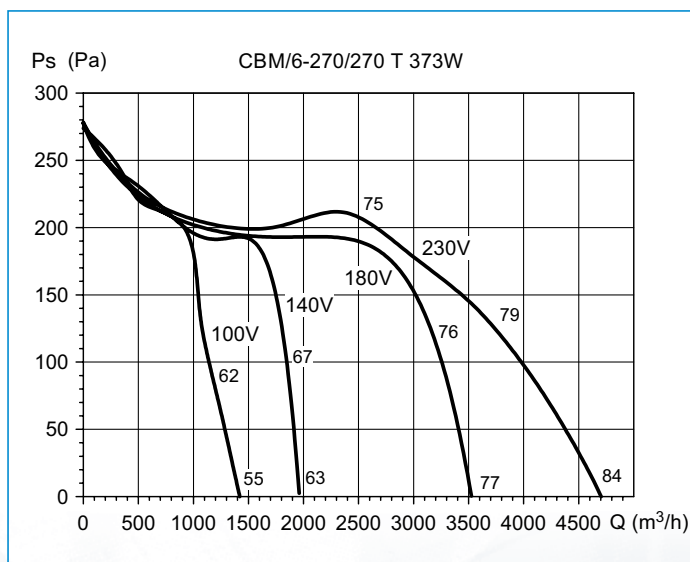
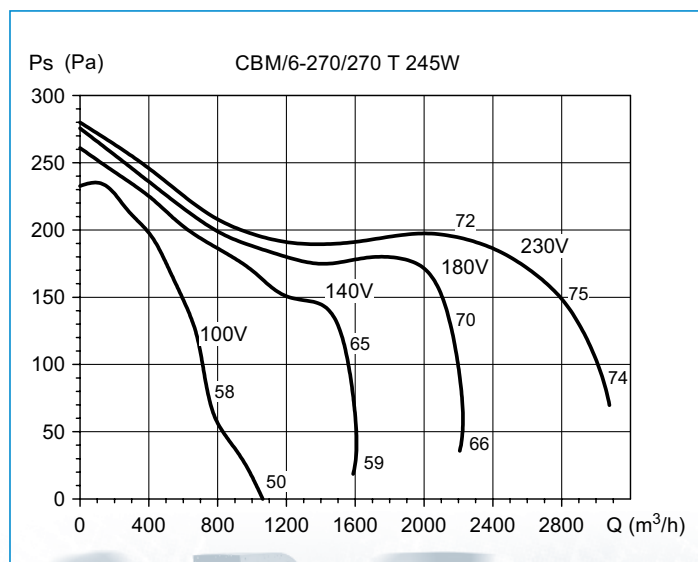
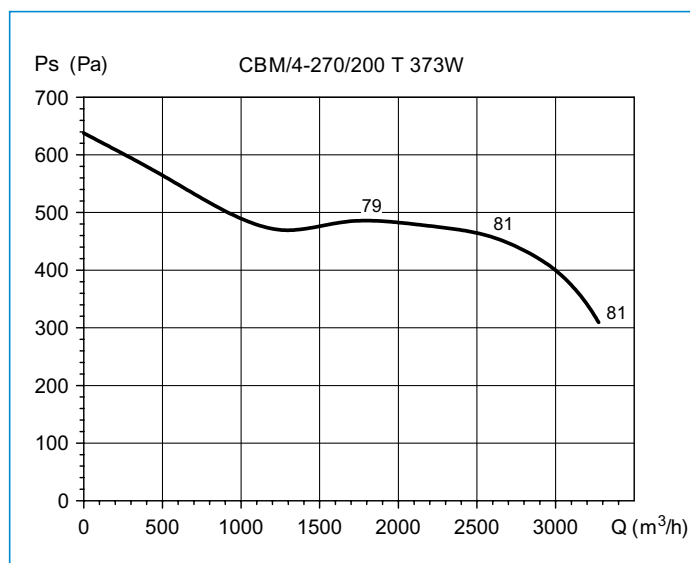
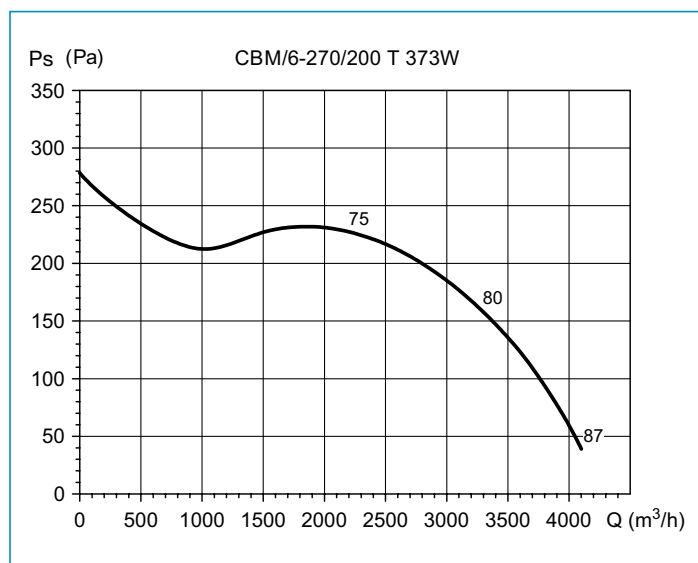
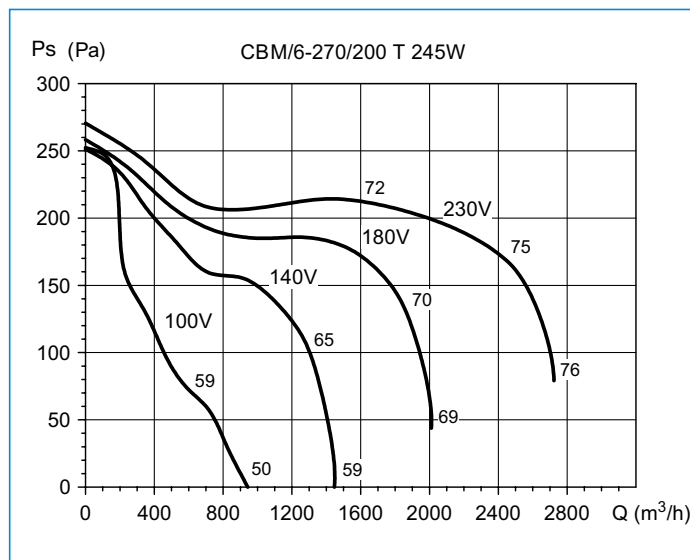
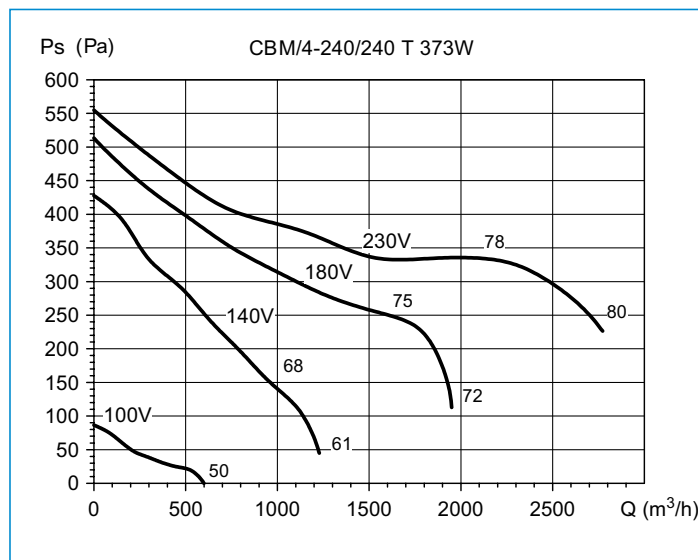

Curves at different voltages are obtained with a transformer type speed controller.

Performance curves

- Q = Air volume in, m³/hr and m³/s.
- Ps = Static pressure in mmWG and Pa.
- Dry air at 20°C and 760 mmHg.
- Performance data in accordance with ISO 5801 and AMCA 210-99 Standards.

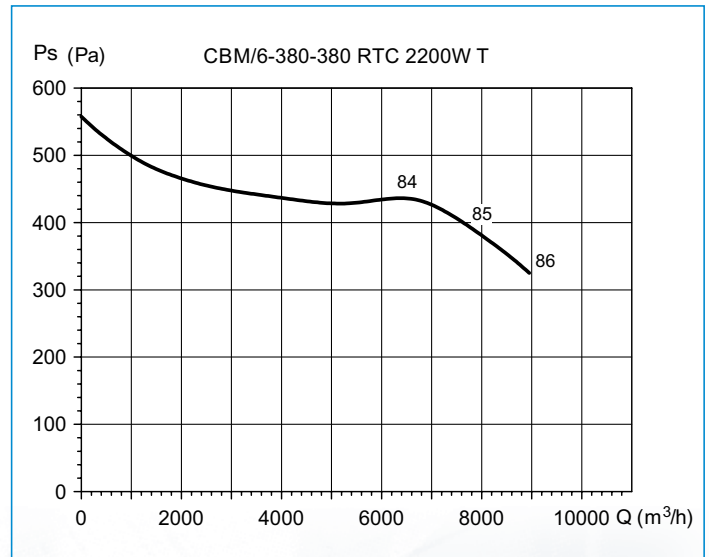
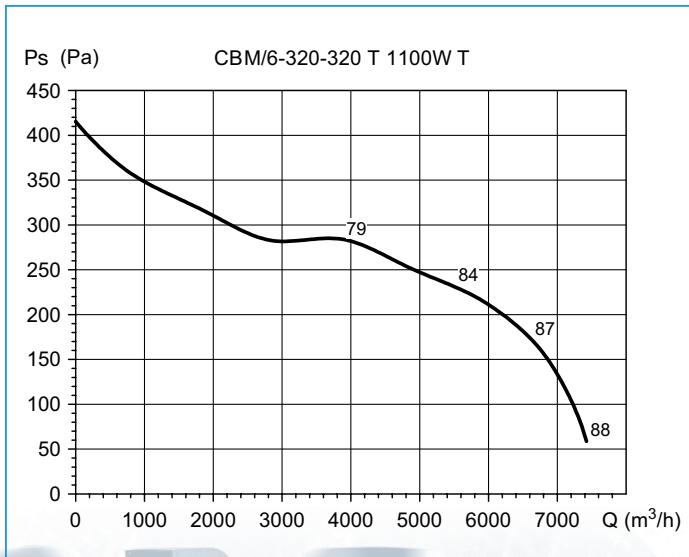
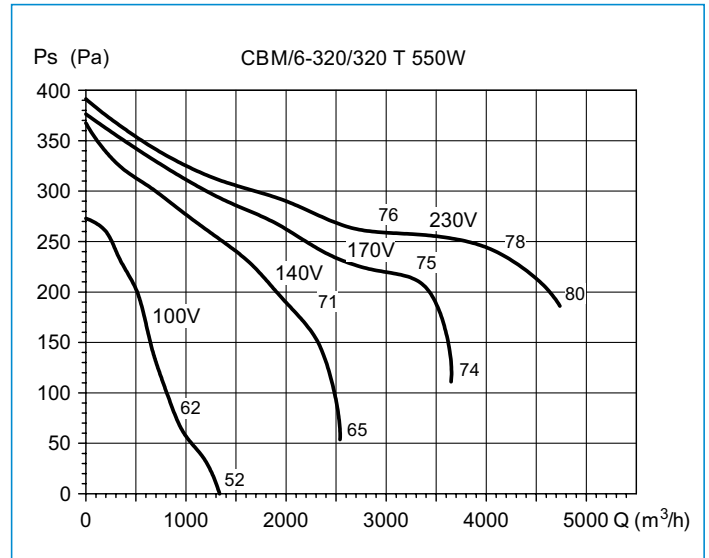
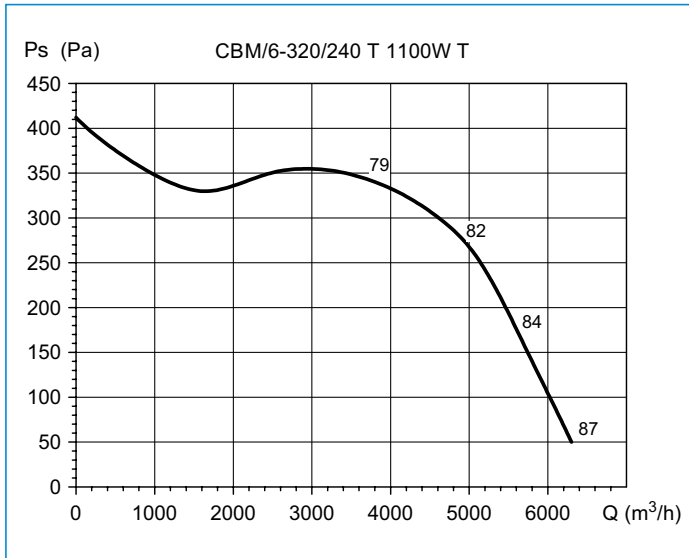
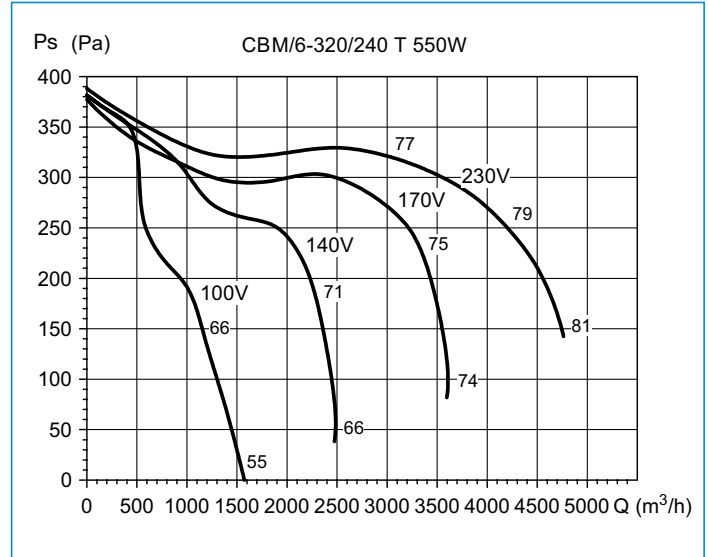
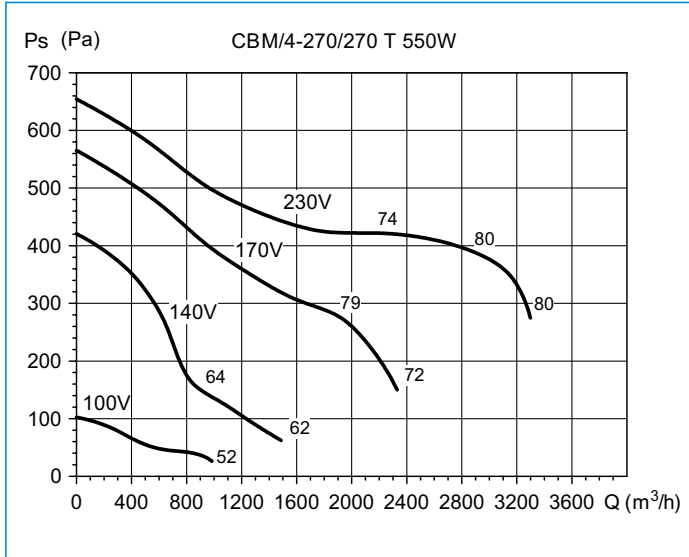

Curves at different voltages are obtained with a transformer type speed controller.